

# The Iberian contribution to cryptic diversity in European bats

Carlos Ibáñez<sup>1</sup>, Juan L. García-Mudarra<sup>1</sup>, Manuel Ruedi<sup>2</sup>, Benoît Stadelman<sup>2</sup> and Javier Juste<sup>1</sup>

<sup>1</sup>*Estación Biológica de Doñana (CSIC), P.O. Box 1056, 41080 Sevilla, Spain*

<sup>2</sup>*Natural History Museum, P.O. Box 6434, 1211 Geneva 6, Switzerland*

Corresponding author: Javier Juste

Estación Biológica de Doñana (CSIC), P.O. Box 1056, 41080 Sevilla, Spain

Phone:+34 955727780

Fax:+34 954621125

*E-mail address:* [juste@ebd.csic.es](mailto:juste@ebd.csic.es)

Running title: Cryptic diversity in Iberian bats

## ABSTRACT

We investigate the contribution of the Iberian bat fauna to the cryptic diversity in Europe using mitochondrial (*cytb* and *ND1*) and nuclear (*RAG2*) DNA sequences. For each of the 28 bat species known for Iberia, samples covering a wide geographic range within Spain were compared to samples taken in Europe. In this general screening, almost 20 % of the Iberian species showed important mitochondrial discontinuities (K2P distance values > 5%) either within the Iberian or between Iberian and other European samples. Within *Eptesicus serotinus* and *Myotis nattereri*, levels of genetic divergence between lineages exceeded 16 %, indicating that these taxa represent a complex of several biological species. Other well-differentiated lineages (K2P distances between 5-10 %) appeared within *Hypsugo savii*, *Pipistrellus kuhlii* and *Plecotus auritus*, suggesting the existence of further cryptic diversity. Most unsuspected lineages seem restricted to Iberia, although two have crossed the Pyrenees to reach, at least, Switzerland.

*Keywords:* Chiroptera; cryptic species; refugia; Europe; Iberia; mitochondrial DNA.

## INTRODUCTION

Species have periodically expanded and contracted their range since at least the Tertiary in response to repeated changes in environmental conditions. Animals and plants experienced long periods of isolation in refugia during glacial episodes, before expanding during inter-glacials. These periodic pulses have had strong consequences on the evolution of organisms' life histories (Dynesius and Jansson, 2000). Because the Gibraltar and Messinian straits remained active as geographic barriers during cold periods, the Iberian, Italian and Balkan Peninsulas in the Mediterranean basin acted as southernmost refugia for many western European species that now have much wider distribution. These areas harbour high levels of biodiversity (Myers *et al.*, 2000), as evidenced by molecular techniques (see e.g. Hewitt, 1996; Taberlet *et al.*, 1998; Ruedi and Castella, 2003). Particularly, the Iberian Peninsula shows a remarkably high level of endemism in both plants and animals (summarized in García-Barros *et al.*, 2002). Temperate habitats and species seem to have persisted in the Iberian Peninsula during the cold periods (Bennet *et al.*, 1991; Olalde *et al.*, 2002), allowing this area to act as an important repository reservoir (Gómez and Lunt, 2006). Molecular techniques also helped uncover cryptic diversity in many groups of animals and plants that remained unsuspected by traditional morphological approaches. The molecular disclosure of cryptic diversity has been particularly important in the Iberian Peninsula in organisms as different as amphibians (Martínez-Solano, 2004; Martínez-Solano *et al.*, 2004) or butterflies (Mensi *et al.*, 1994) that typically show limited dispersal abilities.

Bats make up a highly diverse group that comprises up to 20 % of all European mammal species (Mitchell-Jones *et al.*, 1999). Although bats have a high potential for dispersal, they can display unexpected levels of genetic differentiation and strong geographic genetic structure (reviewed in Ruedi and McCracken, in press). During the last decade, molecular studies have revealed as many as four new cryptic species in mainland Europe:

*Pipistrellus pygmaeus* (Barratt *et al.*, 1997), *Plecotus macrobullaris* and *P. kolombatowici*, (Kiefer *et al.*, 2002; Spitzenberger *et al.*, 2003) and *Myotis alcathoe* (Helvesen *et al.*, 2001). If *Myotis punicus* and *Plecotus sardus* from Corsica and Sardinia (Castella *et al.*, 2000; Mucedda *et al.*, 2002) are added the current number of European bat species increased by up to 20 % after being screened with molecular techniques. Previous molecular studies included, however, only a poor representation of the Iberian bat fauna. For instance only five individuals belonging to four species were studied in the most comprehensive work in search of cryptic diversity at European scale (Mayer and Helversen, 2001). Given the important and complex role as potential depository of diversity played by the Iberian Peninsula, a more representative sampling is necessary to obtain realistic estimates of bat biodiversity and subsequently, to define meaningful conservation plans to protect these globally threatened mammals.

In the present paper we focus on Iberian bat populations to uncover potential cryptic diversity within this ancient glacial refuge. We analyse variation at several molecular markers in all species of bats known to occur in Iberia and compare it with the corresponding lineages sampled elsewhere in Europe. Our ultimate goal is to assess the contribution of the Iberian region to the current and historical diversity of the European bat fauna.

## MATERIAL AND METHODS

### *Study design and sample collection*

The initial screening of lineage diversity covers all 28 species of bats currently known to live in Iberia. These species belong to the families Rhinolophidae, Vespertilionidae, Miniopteridae and Molossidae. The sampling includes the 25 species traditionally accepted from Iberia (Mitchell-Jones *et al.*, 1999), plus three new taxa found

more recently: *P. pygmaeus* (Barrat *et al.*, 1997), *P. macrobullaris* (Garin *et al.*, 2003) and *M. alcaethoe* (Agirre-Mendi *et al.*, 2004). In order to uncover the main geographic components of genetic diversity, four geographically distant samples for each species were selected; two samples were taken from northern and two from southern Iberia (with few exceptions; Appendix A). The non-Iberian lineages ranged from one to six samples per species that were either obtained from GenBank or newly sequenced (Appendix A). For this initial screening of genetic diversity, partial sequences of the mitochondrial (mtDNA) cytochrome *b* gene (*cytb*) were chosen for continuity with comparable studies already available (e.g. Johns and Avise, 1998; Bradley and Baker, 2001).

For five species that showed important genetic discontinuities in the initial screening, a more intensive sampling effort was carried out both within the Iberian Peninsula and in the rest of Europe to obtain more information about variation and distribution of these lineages. A fragment of the mtDNA NADH dehydrogenase gene 1 (*ND1*) was also sequenced for key individuals to check for consistency of results and to provide comparative framework with Mayer and Helversen (2001). For those five species, the recombination activating gene 2 (*RAG2*), a nuclear gene, was also sequenced to confirm that results represent not only unique mtDNA lineages, but correspond to differences in the nuclear genome as well.

### *Genetic analysis*

After extraction of total DNA, samples were amplified with the primers Molcit-F (5'-AAT GACATGAAAAATCACCGTTGT-3') and MVZ-16 (Smith and Patton, 1993) or with ER-65 and ER-66 (Mayer and Helversen, 2001) designed to amplify fragments of the *cytb* and *ND1*, respectively. The PCR cocktail (20µl final reaction volume) included 2µl of DNA extract, 1µl of each primer (10µM), 0.8µl of MgCl<sub>2</sub> (50mM), 0.16µl of dNTP (25mM), 0.5 units of taq-polymerase. Thermocycling consisted in a 4 min initial denaturation at 94°C

followed by 35 cycles of 60s at 94°C, 30s at 45-50°C (for the *cytb*), and 90s at 72°C and a final extension of 10 min at 72°C. The annealing temperature for the *ND1* fragment was 60°C. To amplify a fragment of the *RAG2* gene, we used the primers RAG2-F1 and RAG2-R2 (Baker *et al.*, 2000), and RAG2-R1 and RAG2-F1int (Baker *et al.*, 2000) as internal primers. We optimized the PCR cocktails with following alterations: 0,5 µl of each primers (10µM), 1µl of MgCl<sub>2</sub> (50mM), and an initial denaturation of 2 min. All PCR products were sequenced in both directions using an ABI 3100 automated sequencer (PE Biosystems, Warrington, UK).

### *Sequence and phylogenetic analyses*

DNA fragments were aligned and edited using Sequencher 4.1 (Gene Code Crop.). For the initial screening and for each species, Kimura 2-parameter model (K2P) was used to obtain pairwise distances among *cytb* sequences. We selected this model to obtain the same distance measure as previous studies on bat species (e.g. Kawai *et al.*, 2003). Due to the inevitable heterogeneity of the *cytb* fragments used in the initial screening, a possible effect of fragments' length on the distance value was inspected with a Pearson's correlation coefficient. Species displaying major genetic discontinuities (i.e. distances larger than 5%, Bradley and Baker, 2001) were further investigated in more details with more individuals and markers (Appendix B). In this case, for each marker (*cytb*, *ND1*, *RAG2*) the best fitting substitution model was selected using hierarchical likelihood ratio tests implemented in Modeltest (Posada and Crandall, 1998). Phylogenetic reconstructions were derived from pairwise distances (NJ algorithm, Saitou and Nei, 1987) and under maximum likelihood (ML) criterion (heuristic search) using PAUP\* 4.0b10 (Swofford, 2000). For these analyses, an appropriate outgroup species was chosen according to Mayer and Helversen (2001) in order to polarize trees (Appendix B). Robustness of topologies was estimated with 5,000 bootstrap replicates (Felsenstein, 1985) for NJ and after 300,000 puzzling steps for ML reconstructions. Levels of genetic differentiation within and between groups were also calculated according to a K2P model using MEGA v. 2.1 (Kumar *et al.*, 2001). Because of only a few mutations are present in the *RAG2* sequences, relationships among haplotypes of this gene were also represented by unrooted median-joining networks (Bandelt *et al.*, 1999).

This approach combines the topology of a minimum spanning tree with a parsimony-based search of the absent nodes (median vectors) or haplotypes (Posada and Crandall, 2001). The network was obtained with the software NETWORK 4.1.1.2 (Röhl, 2005) using default parameters.

## RESULTS

### *Overall genetic screening*

For the initial analysis, 146 aligned sequences of the mtDNA *cytb* gene (varying in length from 558 to 803 bp) were obtained for 28 species of bats (Table 1, Appendix A). There was no relation across species between the length of the fragment analyzed and the maximum K2P pairwise distance found for each species ( $r = 0.096$ ,  $P = 0.96$ ). Maximum K2P pairwise distances were smaller than 3% in all but five species, being even less than 1% for most intra-specific comparisons (Fig. 1, Table 1). For the following five species, *Myotis nattereri*, *Pipistrellus kuhlii*, *Hypsugo savii*, *Eptesicus serotinus* and *Plecotus auritus*, comparisons reached over 5 % K2P distance values. This unusual level of intra-specific divergence is indicative of major genetic discontinuities.

### *Genetic discontinuities*

The addition of many more individuals sequenced from various locations in these five species (Appendix B) confirmed the co-occurrence of major mtDNA lineages within the Iberian Peninsula (Fig. 2), regardless of which mitochondrial marker is considered. There was always total congruence between the phylogenetic reconstructions based on NJ and ML approaches (only NJ trees are shown) and with similar bootstrap support (see Table 2 for details of the analyses). The reconstructions based on the *RAG2* showed a variable level of congruence with the mitochondrial-based hypotheses, but support the existence of the most differentiated (>10% K2P distance) mtDNA lineages (Figs. 2 and 3). Within-group

comparisons didn't exceed 1.3 % for the *cytb* gene in all major lineages except for *P. auritus* that reached 2.1% (Fig. 2, Tables 3 – 7). A more detailed description of relationships within each of these highly heterogeneous species follows:

#### 1) *Myotis nattereri* complex

A total of 20 partial sequences of *cytb*, six of *ND1* and seven of *RAG2* were used in the analyses (Appendix B). Three major European lineages are identified by both mtDNA gene trees (Fig. 2a). Each is separated by at least 10% K2P distance and is supported by high bootstrap values (Fig. 2a, Table 3). The most divergent lineage (about 16% K2P distance), marked with red dots in Fig. 2a, appears more closely related to *M. schaubi* from Iran than to other European *nattereri* and seems endemic to the entire Iberian Peninsula. Another divergent lineage was found in bats from mountains of northern Iberia and clusters with the European lineage of *nattereri* living in Germany, Switzerland or Greece (Fig. 2a). The *RAG2* gene confirms the existence of two divergent lineages within Iberian *nattereri* in the trees and the network, but relationships are not congruent with those recovered with mtDNA markers in relation to *M. schaubi* (Figs. 2a and 3a). Notice that the two highly divergent Iberian lineages of *M. nattereri* are found in close geographic proximity in the mountains of northern Iberia (Fig. 2a).

#### 2) *Eptesicus serotinus* complex

A total of 15 partial sequences of *cytb*, seven of *ND1* and six of *RAG2* were used in the analyses (Appendix B). Both mtDNA markers show two deeply diverging lineages (over 16% K2P distance) of *E. serotinus* within Iberia (Fig. 2b, Table 4). As in the previous case, the inclusion of two other species of *Eptesicus* shows that these two serotine bat lineages are not monophyletic (Fig. 2b). Indeed, the lineage that is widespread in Europe is genetically closer to the species *E. nilssonii* than to the southern Iberian lineage (Fig. 2b). Results based on the nuclear *RAG2* gene are congruent with those based on mtDNA markers. The network



connects the European *Eptesicus* with *E. nilssonii* (using one reconstructed haplotype), whereas the southern Iberian lineage connects (needing another reconstructed haplotype) first with *E. bottae* (Figs 2b and 3b). These two main lineages are apparently distributed allopatrically within the Iberian Peninsula.

### 3) *Plecotus auritus* complex

A total of 14 partial sequences of *cytb*, six of the *ND1* and five of *RAG2* were used in the analyses (Appendix B). Again, both mtDNA markers support the distinction of two main lineages within Iberian *P. auritus*. They differ by 5 to 9% K2P distance (Fig. 2c, Table 5). As in previous species one lineage is restricted to the Iberian Peninsula, while the other is more widespread throughout Europe, with no apparent overlap between their distributions (Fig. 2c). Within the European *P. auritus* two further subclades (less than 4% K2P distance) can be recognized in central Europe (e.g. within Switzerland). The relatively slow *RAG2* gene keeps unresolved the relationships of the different lineages, showing in the network similar distances between the lineages within this species complex (Figs. 2c and 3c).

### 4) *Hypsugo savii* complex

A total of 15 partial sequences of *cytb*, six of *ND1* and seven of *RAG2* were used in this analysis (Appendix B). Three main lineages diverging by over 7 % K2P distances are supported by both mtDNA markers (Fig. 2d, Table 6). Relationships among lineages are not resolved with significant bootstrap support, though. One lineage (yellow triangles in Fig. 2d) was found only in two bats from southern Iberia, whereas another Iberian lineage was found as far north as Switzerland. These two lineages are sympatric in Andalusia, southern Spain, where they were found in the same locality. Finally, a third major lineage corresponds to Savi's bats from the eastern Mediterranean (Fig. 2d). Results based on the nuclear *RAG2* also suggest the existence of a differentiated southern Iberian lineage, but again,

relationships among lineages are unresolved (Figs. 2d and 3d).

#### 5) *Pipistrellus kuhlii* complex

A total of 12 partial sequences of *cytb*, six of *ND1* and seven of *RAG2* were used in this analysis (Appendix B). Both mtDNA fragments show two clearly diverging lineages with mean K2P genetic distances around 6 % between them in both markers (Fig. 2e, Table 7). One lineage includes most Iberian samples and extends its distribution to Switzerland whereas the other lineage is apparently found throughout Europe from Southern Iberia to Greece. The two lineages are sympatric in Southern Iberia and in Switzerland (Fig. 2e). Specimens bearing these different lineages shared the same *RAG2* haplotype, and thus were not distinct based on this nuclear marker (Figs. 2e and 3e).

## DISCUSSION

### *New cryptic diversity*

Well-recognized species among bats show typically intra-specific genetic divergence under 2.5 % at the *cytb* or *ND1* (Ditchfield, 2000; Bradley and Baker, 2001; Mayer and Helversen, 2001; Ruedi and Mayer, 2001). Whereas values over 5 % are generally considered to indicate the existence of cryptic taxonomic diversity, values exceeding 10 % are considered in bats as indicative of species-level divergence (Bradley and Baker, 2001). Nevertheless, levels of genetic divergence at mtDNA markers alone are not necessarily sufficient to identify possible cryptic species (Ruedi and McCracken, in press). Following a conservative approach in this study, we propose species level recognition only to those mtDNA lineages highly differentiated (>10 %) that also show indications of morphological and/or ecological differentiation. Inferences based only on mtDNA markers have been criticized because they reflect only an incomplete part of the natural history of the organisms (Ballard and Whitlock, 2003), or may be misled by the presence of pseudogenes (see

Bensasson *et al.*, 2001 for review) and/or affected by the inherent limitations of mtDNA markers (e.g. Hudson and Turelli, 2003). Due to these possible drawbacks, a cross-validation with independent nuclear markers is highly recommended (Zhang and Hewitt, 2003). In our study, the nuclear *RAG2* has recovered all major mtDNA discontinuities (>10 % divergence) found in the *M. nattereri* and *E. serotinus* complexes, but failed to retrieve the other main discontinuities (5% divergence) found with the mtDNA markers in the *Plecotus auritus*, *Pipistrellus kuhlii*, and *H. savii* complexes, probably due to the relative slow rate of evolution of *RAG2*.

According to all three molecular markers, two highly divergent lineages of *M. nattereri*, exist in Iberia apart from the typical European lineage. We have found that one of them, the lineage spread in southern Iberia, shows strict cave-dwelling habits during reproduction, forming breeding colonies up to several hundred individuals. This pattern is in contrast to other European Natterer's bats that form small groups and typically roost within tree holes (Mitchell-Jones *et al.*, 1999). Moreover, these bats can be distinguished by distinct fringing hairs in the tail membrane (C. Ibáñez, and P.T., Agirre-Mendi, in prep.). All together molecular, ecological and morphological differences suggest that that these distinctive Iberian Natterer's bats correspond to a new cryptic species. We propose to name it by virtue of name priority *Myotis escalerae* Cabrera, 1904, a taxon described from Valencia, in the Spanish Mediterranean coast (Ibáñez and Fernández, 1989). A second lineage is found only in the mountains of northern Spain and above 1000 m a.s.l. But contrary to *Myotis escalerae*, these Natterer's bats typically roost and install small breeding colonies within tree holes like other European Natterer's bats and never form breeding colonies in caves. This second lineage shows highly differentiated haplotypes, with K2P genetic distances over 10 % compared to both *M. escalerae* and the European *M. nattereri* (Table 3). This level of differentiation could also indicate species status (Bradley and Baker,

2001), but because no morphological or ecological character was found to distinguish them from typical European *M. nattereri*, we refrain from describing it herein, as a new species until this lineage is studied in-depth. Relationships among lineages remain uncertain since mtDNA and nuclear markers suggest different sister-groups. Therefore, more extensive taxon sampling is needed to clarify the precise phylogenetic position of these lineages.

In the *E. serotinus* complex, both mtDNA and nuclear markers show a paraphyletic arrangement of haplotypes. The north Iberian - European lineage, corresponds to individuals representing the nominal *E. serotinus* (Schreber, 1774) described originally from France. This lineage appears phylogenetically more closely related to *E. nilssonii* than to the lineage found in southern Iberia. Moreover, we found during the sampling that bats bearing the southern Iberian lineage show a yellowish and much paler pelage than the serotine bats found in northern Iberia. In fact, a careful check of about 100 specimens sampled in Andalusia and examined molecularly has failed to detect any typical, dark serotine bat bearing north Iberian haplotypes. These evidences clearly support that the pale, southern Iberian serotines represent another distinct, cryptic species. Two names would be available for these pale serotines: *E. isabellinus* (Temminck, 1839) described from northern Africa and *E. boscai* (Cabrera, 1904) described from Spain. Additional genetic studies are needed to ascertain whether the southern Iberian lineage corresponds to the North African serotines. In this case, *isabellinus* would have priority over *boscai*.

Regarding the long-eared bats, the two major lineages identified molecularly correspond to animals from two distinct subspecies: *P. a. auritus* from Western Europe and *P. a. begognae* from central Iberia (de Paz, 1994; Juste *et al.*, 2004). Both are morphologically distinct and distributed allopatrically in Iberia with no apparent geographic barrier separating them. The scattered populations of typical *P. a. begognae* can be geographically more distant from each other, than they are from typical *P. a. auritus*, like in

the Ebro valley where known populations of each subspecies live less than 30 km apart.

Sequences of the *RAG2* do not provide enough resolution to infer phylogenetic relationships, but support their molecular distinctness.

The species *P. kuhlii* and *H. savii* display important, but shallower levels of genetic differentiation. In both species, two major lineages: one Western and one Eastern European are revealed by the mtDNA, although not recovered by the *RAG2*. This gene was poorly informative at this level of differentiation. In the case of *P. kuhlii*, the Western and Eastern mtDNA lineages meet in Switzerland. Apart from these lineages, both species show rare haplotypes that seem restricted to southern Iberia. These haplotypes could represent ancestral polymorphisms or recent colonization events from extraneous populations, i.e. immigrants from northern Africa.

The Western and Eastern lineages could underlie the existence of distinct subspecies in both *P. kuhlii* and *H. savii* but their final taxonomic considerations need further morphological and ecological studies to be ascertained.

The remaining 23 species of bats living in Spain and screened with genetic markers, did not show unusual levels of intra-specific differentiation (Fig. 1), suggesting that most of their diversity in western Europe has been captured in previous surveys (e.g. Mayer and Helversen, 2001; Ruedi and Castella, 2003).

#### *Origin and distribution of the new cryptic diversity*

The five species complexes of bats showing unexpected levels of genetic divergence also show distinctive phylogenetic patterns, indicating that they experienced unique evolutionary histories and/or reacted differently to past climatic fluctuations. The divergence time between *M. nattereri* and *M. schaubi* is dated directly from fossil material at around 5.5 and 6.5 MYA (Horáček and Hanák, 1984). The split between *M. escalerae* and *M. nattereri*

would then correspond at least to that time period. The genetic distances between *E. serotinus* and the new Iberian taxon is of the same magnitude and thus also correspond to a Late Miocene - Early Pliocene divergence. This epoch coincided with dramatic geographical and environmental changes associated to the Messinian crisis in the Mediterranean (Blondel and Aronson, 1999). The substitution rate in the *cytb* DNA has been estimated between the 3.5 % for the genus *Plecotus* (Juste *et al.*, 2004) and 4.8 % per million years for *Myotis* (Ruedi and Mayer, 2001). Applying a mean substitution rate of 4%, we can estimate roughly that the lineages within *P. auritus*, *H. savii*, and *P. kuhlii* would have diverged about 2.25 - 1.5 MYA, during the Early Pleistocene. The recurrent cold periods that occurred during the Pleistocene, would have favoured the differentiation and/or the persistence of these lineages in Iberia.

Our screening focusing on the Iberian Peninsula has confirmed the importance of this area as a reservoir of biodiversity. In fact, 10 major, cryptic lineages exist nowadays in Iberia within the five bat species complexes bearing genetic discontinuity. The special geographic features of Iberia have determined its particular function as a refuge (Gómez and Lunt, 2006). In fact, a variety of concordant patterns of genetic structure are described among different groups of animals and plants. This concordance is supporting the consideration of Iberia more as a mosaic of suitable refugia than as a unique and homogenous unit (Gómez and Lunt, 2006).

The high diversity of bat lineages in Iberia could also result from a slower expansion of relict populations during inter-glacials compared to other refuge areas. The presence of several mountain ridges oriented west-east, and particularly the massif of the Pyrenees, could have hampered or delayed the expansion of the Iberian lineages when the ice conditions retreated. Instead, the lineages sheltered in the Balkans could have spread rapidly over Europe (including Iberia), according to the so-called grasshopper paradigm (Hewitt,

1996). On the other hand, recent evidence (e.g. Alvarez *et al.*, 2001; Carranza *et al.*, 2004) suggest that the Strait of Gibraltar was a porous barrier even for organisms predicted to have very low dispersal abilities (e.g. amphibians and reptiles) and part of the Iberian bat lineages could be immigrant from North Africa.

Only a few bats, *Myotis myotis*, (Ruedi and Castella, 2003), *Plecotus* sp. (Juste *et al.*, 2004), *Nyctalus noctula* (Petit and Mayer, 1999) and *Pipistrellus* sp. (Hulva *et al.*, 2004) have been studied molecularly at the European scale. Whereas the long-distance migrant noctules show little genetic structure, the other studied species increase their genetic diversity southwards, in agreement with models of postglacial range expansion. The haplotype distribution reported here within *H. savii* and *P. kuhlii*, support also the confluence of lineages in central Europe (Switzerland), as it was found in the mouse-eared bats *Myotis* (Ruedi and Castella, 2003) or in other organisms (Petit *et al.*, 2003). Nevertheless, it is still necessary to gather more information at this geographic scale before general phylogeographic patterns can be generalized for the whole guild of European bats.

Distribution ranges of European bats cover typically large areas (Mitchell-Jones *et al.*, 1999). The recently recognized species, *M. alcaethoe* and *P. macrobullaris*, were originally described as endemic to the Balkans (Helvesen *et al.*, 2001; Spitzenberger *et al.*, 2001), but they proved later to be more widely distributed across Europe (Ruedi *et al.*, 2002; Garín *et al.*, 2003; Agirre-Mendi *et al.*, 2004). The new cryptic taxa found in our screening seem to show a relatively restricted distribution in south-western Europe, which might explain why they remained undetected in previous molecular surveys (Mayer and Helversen, 2001). It is possible, though, that these new taxa also occur in northern Africa, where the same species complexes are known to occur but were not yet analyzed molecularly. Therefore, we refrain to consider *M. escalerai* and *E. isabellinus/boscai* as strict Iberian endemics until their distribution is studied south of the Gibraltar strait.

Finally, our results show the necessity to include representative sampling of all areas potentially important as diversity refuges (like Iberia) in order to obtain accurate estimates of biodiversity. Bats constitute the most endangered group of mammals in Europe according to the Annex II of the European Union's Directive on the protection of wild fauna and flora (Council Directive 92/43/EEC of 21 May 1992 on the conservation of natural habitats and of wild fauna and flora). The continuous finding of cryptic lineages or even new species during the last years is challenging our understanding of the real distribution range of several European bats. Thus several more species of bats might be under local risk of extinction, given that distribution is a major factor to explain extinction risk in bats (Jones *et al.*, 2003). Further molecular surveys designed to uncover cryptic taxa should be a priority in order to be able to build more accurate conservation strategies for the protection of European bat fauna.

#### ACKNOWLEDGEMENTS

We are particularly grateful to P.T. Agirre-Mendi, A. Fijo, J.A. Garrido, E. Migens, J. Nogueras, J. Quetglas, for helping in the field work. I. Ahlén, J.R. Aihartza, J.T. Alcalde, A. Arrizabalaga, J.J. Bafaluy, J. Fernández, C. Flaquer, I. Garin, U. Häussler, A. Karataş, G. Kerth, the 'Golobis', 'Lutra' and 'Roncadell' groups, contributed with samples. J. Muñoz and M.A. Seda helped in the lab. This research is part of the projects REN2000-1639 and REN2002-01372 /GLO funded by the Dirección General de Investigación of the Spanish Ministry of Science and Technology. Financial support was also provided by a Swiss National Funds for Scientific Research (# 3100A0-105588).

#### LITERATURE CITED



- Agirre-Mendi, P. T., J. L. García-Mударra, J. Juste, and C. Ibáñez. 2004. Presence of *Myotis alcathoe* Helversen & Heller 2001 (Chiroptera: Vespertilionidae) in the Iberian Peninsula. *Acta Chiropterologica*, 6: 49-57.
- Alvarez, Y., J. A. Mateo, A. C. Andreu, C. Díaz-Paniagua, A. Díez, and J. M. Bautista. 2000. Mitochondrial DNA haplotyping of *Testudo graeca* on both continental sides of the Straits of Gibraltar. *Journal of Heredity*, 91: 39-41.
- Baker, R. J., C. A. Porter, J. C. Patton, and R. A. Van Den Busche. 2000. Systematics of bats of the family Phyllostomidae based on RAG2 DNA sequences. *Occasional Papers Museum, Texas Tech University*, 202: 1–16.
- Ballard, J. W., and M. C. Whitlock. 2003. The incomplete natural history of mitochondria. *Molecular Ecology*, 13: 729-744.
- Bandelt, H. J., P. Forster, and A. Röhl. 1999. Median-joining networks for inferring intraspecific phylogenies. *Molecular Biology and Evolution*, 16: 36-48.
- Barratt, E. M., R. Deaville, T. M. Burland, M. W. Bruford, G. Jones, P. A. Racey, and R. Wayne. 1997. DNA answers the call of pipistrelle bat species. *Nature*, 387: 138-139.
- Benda, P., A. Kiefer, V. Hanák, and M. Veith. 2004. Systematic status of African populations of long-eared bats, genus *Plecotus* (Mammalia: Chiroptera). *Folia Zoologica*, 53: 1–47.
- Benda, P., and K. A. Tsytsulina. 2000. Taxonomic revision of *Myotis mystacinus* group (Mammalia: Chiroptera) in the western Palaearctic. *Acta Societas Zoologicae Bohemicae*, 64: 331-398.
- Bennet, K. D., P. C. Tzedakis, and K. J. Willis. 1991. Quaternary refugia of north European trees. *Journal of Biogeography*, 18: 103-115.

- Bensasson, D., D.-X. Zhang, D. L. Hartl, and G. M. Hewitt. 2001. Mitochondrial pseudogenes: evolution's misplaced witness. *Trends in Ecology and Evolution*, 16: 314-321.
- Blondel, J., and J. Aronson. 1999. *Biology and Wildlife of the Mediterranean Region*. Oxford University Press, New York, xxii + 328 pp.
- Bradley, R. D., and R. J. Baker. 2001. A test of the genetic species concept: cytochrome-*b* sequences and mammals. *Journal of Mammalogy*, 82: 960-973.
- Castella, V., M. Ruedi, L. Excoffier, C. Ibáñez, R. Arlettaz, and J. Hausser. 2000. Is the Gibraltar Strait a barrier to gene flow for the bat *Myotis myotis* (Chiroptera: Vespertilionidae)? *Molecular Ecology*, 9: 1761-1772.
- Carranza, S., E. N. Arnold, E. Wade, and S. Fahd. 2004. Phylogeography of the false smooth snakes, *Macroprotodon* (Serpentes, Colubridae): mitochondrial DNA sequences show European populations arrived recently from Northwest Africa. *Molecular Phylogenetic and Evolution*, 33: 523-532.
- de Paz, O. 1994. Systematic position of *Plecotus* (Geoffroy, 1818) from the Iberian Peninsula (Mammalia: Chiroptera). *Mammalia*, 58: 423-432.
- Ditchfield, A. D. 2000. The comparative phylogeography of Neotropical mammals: patterns of intraspecific mitochondrial DNA variation among bats contrasted to nonvolant small mammals. *Molecular Ecology*, 9: 1307-1318.
- Dynesius, M., and R. Jansson. 2000. Evolutionary consequences of changes in species' geographical distributions driven by Milankovitch climate oscillations. *Proceedings of the National Academy of Sciences*, 97: 9115-9120.
- Felsenstein, J. 1985. Confidence limits on phylogenies: an approach using the bootstrap. *Evolution*, 39: 783-791.

- García-Barros, E., P. Gurrea, M. J. Luciáñez, J. M. Cano, M. L. Munguira, J. C. Moreno, H. Sainz, M. J. Sanz, and J. C. Simón. 2002. Parsimony analysis of endemism and its application to animal and plant geographical distributions in the Ibero-Balearic region (Western Mediterranean). *Journal of Biogeography*, 29: 109-124.
- Garin, I., J. L. García-Mudarra, J. R. Ahiartza, U. Goiti, and J. Juste. 2003. Presence of *Plecotus macrobullaris* (Chiroptera: Vespertilionidae) in the Pyrennes. *Acta Chiropterologica*, 5: 243-250.
- Gómez, A., and D. H. Lunt. 2006. Refugia within refugia: patterns of phylogeographic concordance in the Iberian Peninsula. In the press, *in* *Phylogeography of Southern European Refugia* (S. Weiss, and N. Ferrand, eds.). Kluwer Academic Publishers, Dordrecht, Netherlands.
- Helversen, O. von, K.-G. Heller, F. Mayer, A. Nemeth, M. Volleth, and P. Gombkötö. 2001. Cryptic mammalian species: a new species of whiskered bat (*Myotis alcathoe* n. sp.) in Europe. *Naturwissenschaften*, 88: 217-223.
- Hewitt, G. M. 1996. Some genetic consequences of ice ages, and their role in divergence and speciation. *Biological Journal of the Linnean Society*, 58: 247-276.
- Horáček, I., and V. Hanák. 1984. Comments on the systematics and phylogeny of *Myotis nattereri* (Kuhl, 1818). *Myotis*, 21-22: 20-29.
- Hudson, R. R., and M. Turelli. 2003. Stochasticity overrules the three times rule: genetic drift, genetic draft and coalescence times for nuclear versus mitochondrial DNA. *Evolution*, 57: 182-190.
- Hulva, P., I. Horáček, P. P. Strelkov, and P. Benda. 2004. Molecular architecture of *Pipistrellus pipistrellus/Pipistrellus pygmaeus* complex (Chiroptera: Vespertilionidae): further cryptic species and Mediterranean origin of the divergence. *Molecular Phylogenetic and Evolution*, 32: 1023-1035.

- Ibáñez, C., and R. Fernández. 1989. Catálogo de murciélagos de las colecciones del Museo Nacional de Ciencias Naturales. Monografías Museo Nacional de Ciencias Naturales, 2: 1-54.
- Johns, G. C., and J. C. Avise. 1998. A comparative summary of genetic distances in the vertebrates from the mitochondrial cytochrome b gene. *Molecular Biology and Evolution*, 15: 1481-1490.
- Jones, K., A. Purvis, and J. L. Gittleman. 2003. Biological correlates of extinction risk in bats. *American Naturalist*, 161: 601-614.
- Juste, J., C. Ibáñez, D. Trujillo, J. Muñoz, and M. Ruedi. 2003. Phylogeography of barbastelle bats (*Barbastella barbastellus*) in the western Mediterranean and the Canary Islands. *Acta Chiropterologica*, 5: 165-175.
- Juste, J., C. Ibáñez, J. Muñoz, D. Trujillo, P. Benda, A. Karataş, and M. Ruedi. 2004. Mitochondrial phylogeography of the long-eared bats (*Plecotus*) in the Mediterranean Palearctic and Atlantic Islands. *Molecular Phylogenetic and Evolution*, 31: 1114-1126.
- Kawai, K., M. Nikaido, M. Harada, S. Matsumura, L.-K. Lin, Y. Wu, M. Hasegawa, and N. Okada. 2003. The status of the Japanese and East Asian bats of the genus *Myotis* (Vespertilionidae) based on mitochondrial sequences. *Molecular Phylogenetic and Evolution*, 28: 297-307.
- Kiefer, A., F. Mayer, J. Kosuch, O. von Helversen, and A. Veith. 2002. Conflicting molecular phylogenies of European long-eared bats (*Plecotus*) can be explained by cryptic diversity. *Molecular Phylogenetic and Evolution*, 25: 557-566.
- Kumar, S., K. Tamura, I. B. Jakobsen, and M. Nei. 2001. MEGA2: Molecular Evolutionary Genetics Analysis Software. Arizona State University, Tempe, Arizona.
- Martínez-Solano, I. 2004. Phylogeography of Iberian *Discoglossus* (Anura: Discoglossidae). *Journal of Zoological Systematics and Evolutionary Research*, 42: 298-305.

- Martínez-Solano, I., H. A. Gonçalves, J. W. Arntzen, and M. García-París. 2004. Phylogenetic relationships and biogeography of midwife toads (Discoglossidae: *Alytes*). *Journal of Biogeography*, 31: 603–618.
- Mayer, F., and O. von Helversen. 2001. Cryptic diversity in European bats. *Proceedings of the Royal Society B*, 268: 1825-1832.
- Mensi, P., A. Lattes, L. Cassuolo, and E. Balletto. 1994. Biochemical taxonomy and evolutionary relationships in *Polyommatus* (subgenus *Agrodiaetus*) (Lepidoptera, Lycaenidae). *Nota Lepidopterologica Supplement*, 5: 105–114.
- Mitchell-Jones, A. J., G. Amori, W. Bogdanowicz, B. Kryštufek, P. J. H. Reijnders, F. Spitzenberger, M. Stubbe, J. B. M. Thissen, V. Vohralík, and J. Zima. 1999. *Atlas of European Mammals*. Academic Press, London, xi + 484 pp.
- Mucedda, M., A. Kiefer, E. Pidinchedda, and M. Veith. 2002. A new species of long-eared bat (Chiroptera, Vespertilionidae). *Acta Chiropterologica*, 4: 121-135.
- Myers, N., R. A. Mittermeier, C. G. Mittermeier, G. A. B. da Fonseca, and J. Kent. 2000. Biodiversity hotspots for conservation priorities. *Nature*, 403: 853-858.
- Olalde, M., A. Herrán, S. Espinel, and P. G. Goicoechea. 2002. White oaks phylogeography in the Iberian Peninsula. *Forest Ecology and Management*, 156: 89–102.
- Petit, E., and F. Mayer. 1999. Male dispersal in noctule bat (*Nyctalus noctula*): where are the limits? *Proceedings of the Royal Society B*, 266: 1717- 1722.
- Petit, R. J., I. Aguinagalde, J. L. Christiane Bittkau, S. Brewer, R. Cheddadi, R. Ennos, S. Fineschi, D. Grivet, M. Lascoux, A. Mohanty, G. Müller-Starck, B. Demesure-Musch, A. Palme, J. P. Martí, S. Rendell, and G. Vendramin. 2003. Glacial refugia: hotspots but not melting pots of genetic diversity. *Science*, 300: 1563-1565.
- Posada, D., and K. A. Crandall. 1998. MODELTEST: testing the model of DNA substitution. *Bioinformatics*, 14: 817-818.

- Posada, D., and K. A. Crandall. 2001. Intraspecific gene genealogies: trees grafting into networks. *Trends in Ecology and Evolution*, 16: 37-45.
- Röhl, A. 2005. Network, Version 4.1.1.2: a program package for calculating phylogenetic networks. Mathematics Seminar, University Hamburg, Hamburg, Germany (<http://www.fluxus-engineering.com>).
- Ruedi, M., and V. Castella. 2003. Genetic consequences of the ice ages on nurseries of the bat *Myotis myotis*: a mitochondrial and nuclear survey. *Molecular Ecology*, 12: 1527-1540.
- Ruedi, M., P. Jourde, P. Giosa, M. Barataud, and S. Y. Roué. 2002. DNA reveals the existence of *Myotis alcathoe* in France (Chiroptera: Vespertilionidae). *Revue suisse de Zoologie*, 109 : 643-652.
- Ruedi, M., and F. Mayer. 2001. Molecular systematics of bats of the genus *Myotis* (Vespertilionidae) suggests deterministic ecomorphological convergences. *Molecular Phylogenetic and Evolution*, 21: 436-448.
- Ruedi, M., and G. F. McCracken. in press. Genetics and evolution: phylogeographic analysis. In the press, *in Ecological and Behavioral Methods for the Study of Bats*. 2nd ed. (T. H. Kunz, and S. Parsons, eds.). Johns Hopkins University Press, Boston.
- Saitou, N., and M. Nei. 1987. The neighbor-joining method : a new method for reconstructing phylogenetic trees. *Molecular Biology and Evolution*, 4: 406-425.
- Smith, M. F., and J. L. Patton. 1993. The diversification of South American murid rodents: evidence from mitochondrial DNA sequence data for akodontine tribe. *Biological Journal of the Linnean Society*, 50: 149-177.
- Spitzenberger, F., J. Piálek, and E. Haring. 2001. Systematics of the genus *Plecotus* (Mammalia, Vespertilionidae) in Austria based on morphometric and molecular investigations. *Folia Zoologica*, 50: 161-172.

- Spitzenberger, F., P. Strelkov, and E. Haring. 2003. Morphology and mitochondrial DNA sequences show that *Plecotus alpinus* Kiefer & Veith, 2002 and *Plecotus microdontus* Spitzenberger, 2002 are synonyms of *Plecotus macrobullaris* Kuzjakin, 1965. *Natura Croatica*, 12: 39-53.
- Stadelmann, B., L. G. Herrera, J. Arroyo-Cabrales, J. J. Flores-Martínez, B. P. May, and M. Ruedi. 2004a. Molecular systematics of the fishing bat *Myotis (Pizonyx) vivesi*. *Journal of Mammalogy*, 85: 133-139.
- Stadelmann, B., D. S. Jacobs, C. Schoeman, and M. Ruedi. 2004b. Phylogeny of African *Myotis* bats (Chiroptera, Vespertilionidae) inferred from cytochrome b sequences. *Acta Chiropterologica*, 6: 177–192.
- Swofford, D. L. 2000. PAUP\*. Phylogenetic Analysis Using Parsimony – (and other methods) v. 4.0b10. Sinauer Associates, Sunderland, Massachusetts.
- Taberlet, P., L. Fumagalli, A.-G. Wust-Saucy, and J.-F. Cousson. 1998. Comparative phylogeography and postglacial colonization routes in Europe. *Molecular Ecology*, 7: 453-464.
- Zhang, D.-X., and G. Hewitt. 2003. Nuclear DNA analyses in genetic studies of populations: practice, problems and prospects. *Molecular Ecology*, 12: 563-584.

Table 1. Species, *cytb* fragment length (bp) and results of pair-wise comparisons of K2P genetic distances among samples for each of the 28 bat species (see Appendix A for details).

Species	bp	mean $\pm$ SD (range) (number of comparisons)
<i>Rhinolophus euryale</i>	668	0.00 $\pm$ 0.00 (0.00 – 0.00) (10)
<i>R. ferrumequinum</i>	767	0.13 $\pm$ 0.191 (0.00 – 0.39) (15)
<i>R. hipposideros</i>	778	1.23 $\pm$ 0.610 (0.00 – 1.70) (10)
<i>R. mehelyi</i>	610	0.77 $\pm$ 0.670 (0.00 – 1.16) (3)
<i>Myotis alcathoe</i>	778	0.34 $\pm$ 0.075 (0.26 – 0.39) (3)
<i>M. bechsteinii</i>	768	0.21 $\pm$ 0.126 (0.00 – 0.39) (10)
<i>M. blythii</i>	600	0.94 $\pm$ 0.767 (0.00 – 2.04) (15)
<i>M. capaccinii</i>	803	0.61 $\pm$ 0.783 (0.0 – 1.52) (10)
<i>M. emarginatus</i>	773	0.26 $\pm$ 0.106 (0.13 – 0.39) (10)
<i>M. daubentonii</i>	780	1.69 $\pm$ 0.779 (0.00 – 2.63) (15)
<i>M. myotis</i>	558	0.35 $\pm$ 0.249 (0.00 – 0.74) (10)
<i>M. mystacinus</i>	778	0.31 $\pm$ 0.174 (0.00 – 0.52) (10)
<i>M. nattereri</i>	768	11.21 $\pm$ 6.604 (0.13 – 17.50) (15)
<i>Pipistrellus kuhlii</i>	782	3.26 $\pm$ 2.917 (0.00 – 6.06) (15)
<i>P. nathusii</i>	802	0.33 $\pm$ 0.145 (0.25 – 0.50) (3)
<i>P. pipistrellus</i>	782	0.70 $\pm$ 0.253 (0.26 – 0.90) (10)
<i>P. pygmaeus</i>	734	0.38 $\pm$ 0.295 (0.00 – 0.83) (10)
<i>Hypsugo savii</i>	693	4.84 $\pm$ 3.853 (0.00 – 8.36) (15)
<i>Nyctalus lasiopterus</i>	763	0.40 $\pm$ 0.176 (0.13 – 0.66) (10)
<i>N. leisleri</i>	726	0.53 $\pm$ 0.327 (0.00 – 0.98) (10)
<i>N. noctula</i>	796	0.42 $\pm$ 0.194 (0.25 – 0.63) (3)
<i>Eptesicus serotinus</i>	727	10.28 $\pm$ 8.582 (0.14 – 17.16) (10)
<i>Barbastella barbastellus</i>	680	1.38 $\pm$ 0.772 (0.00 – 2.30) (21)
<i>Plecotus auritus</i>	696	3.84 $\pm$ 2.769 (0.15 – 8.12) (45)
<i>P. austriacus</i>	680	1.07 $\pm$ 0.621 (0.30 – 1.80) (10)
<i>P. macrobullaris</i>	680	0.39 $\pm$ 0.086 (0.29 – 0.44) (3)
<i>Miniopterus schreibersii</i>	755	0.32 $\pm$ 0.222 (0.00 – 0.67) (21)
<i>Tadarida teniotis</i>	762	0.20 $\pm$ 0.164 (0.00 – 0.53) (15)



Table 2. Characteristics, models and parameters of the phylogenetic reconstructions obtained for the mtDNA *cytb* and *ND1* and the nuclear *RAG2* markers and for five bat species complexes studied in detail. TrN, Tamura-Nei'1993 model; HKY, Hasegawa-Kishino-Yano' 1985 model; F81, Felsestein' 1981 model; K80, Kimura' 1980 model; G, gamma shape parameter.

	No. Samples	No. Haplotypes	Length (bp)	Model	G	(-) Ln ML
<i>Myotis nattereri</i>						
<i>Cytb</i>	21	16	768	TrN+G	0.3175	2480.553
<i>ND1</i>	7	7	605	TrN+G	0.3376	1779.277
<i>RAG2</i>	7	3	1165	HKY	*	1746.455
<i>Eptesicus serotinus</i>						
<i>Cytb</i>	15	11	727	HKY	*	1646.144
<i>ND1</i>	7	7	578	HKY+G	0.2505	1282.870
<i>RAG2</i>	6	5	1149	HKY	*	1722.954

---

*Plecotus auritus*

<i>Cytb</i>	14	14	680	HKY+G	0.2098	1587.232
<i>ND1</i>	6	6	420	HKY+G	0.1968	901.129
<i>RAG2</i>	5	4	1162	F81	*	1631.184

---

*Hypsugo savii*

<i>Cytb</i>	15	12	779	HKY+G	0.1492	1874.197
<i>ND1</i>	6	6	500	HKY+G	0.1212	1135.833
<i>RAG2</i>	7	6	827	K80	*	1256.970

---

*Pipistrellus kuhlii*

<i>Cytb</i>	12	10	780	HKY+G	0.3769	1688.067
<i>ND1</i>	6	6	542	HKY+G	0.1786	1099.239
<i>RAG2</i>	7	3	1165	HKY	*	1754.315

---

Table 3. K2P genetic distances (%) between the main lineages of *Myotis nattereri* complex estimated from fragments of the mtDNA genes *cytb* (above diagonal) and *ND1* (below diagonal); the diagonal corresponds to the within-group genetic divergence estimated for the *cytb* in each lineage. See Fig. 2a and Appendix B for identification of lineages and used specimens.

Lineage	(1)	(2)	(3) ■	(4) ▲	(5) ●
1. <i>Myotis myotis</i> (outgroup)	---	16.5	13.4	13.2	16.7
2. <i>Myotis schaubi</i>	16.5	---	19.1	17.8	11.7
3. <i>Myotis nattereri</i> Europe ■	13.4	13.3	<b>0.7</b>	10.4	15.4
4. <i>Myotis nattereri</i> North Iberia ▲	13.2	13.8	10.4	<b>1.0</b>	17.8
5. <i>Myotis nattereri</i> Iberia ●	16.7	12.4	14.6	13.8	<b>0.9</b>

Table 4. K2P genetic distances (%) between the main lineages of *Eptesicus serotinus* complex estimated from fragments of the mtDNA genes *cytb* (above diagonal) and *ND1* (below diagonal); the diagonal corresponds to the within-group genetic divergence estimated for the *cytb* in each lineage. See Fig. 2b and Appendix B for identification of lineages and used specimens.

Lineage	(1)	(2)	(3) ■	(4) ●
1. <i>Eptesicus bottae anatolicus</i> (outgroup)	---	10.5	10.2	15.2
2. <i>Eptesicus nilssonii</i>	9.2	---	1.4	16.9
3. <i>Eptesicus serotinus</i> Europe ■	9.7	1.1	<b>0.2</b>	16.7
4. <i>Eptesicus serotinus</i> South Iberia ●	16.5	16.6	16.9	<b>0.1</b>

Table 5. K2P genetic distances (%) between the main lineages of *Plecotus auritus* complex estimated from fragments of the mtDNA genes *cytb* (above diagonal) and *ND1* (below diagonal); the diagonal corresponds to the within-group genetic divergence estimated for the *cytb* in each lineage. See Fig. 2c and Appendix B for identification of lineages and used specimens.

Lineage	(1)	(2) ■	(3) ●
1. <i>Plecotus macrobullaris</i> (outgroup)	---	13.7	13.9
2. <i>Plecotus auritus auritus</i> Europe ■	18.9	<b>1.9</b>	9.0
3. <i>Plecotus auritus begognae</i> Iberia ●	17.7	4.6	<b>1.0</b>

Table 6. K2P genetic distances (%) between the main lineages of *Hypsugo savii* complex estimated from fragments of the mtDNA genes *cytb* (above diagonal) and *ND1* (below diagonal); the diagonal corresponds to the within-group genetic divergence estimated for the *cytb* in each lineage. See Fig. 2d and Appendix B for identification of lineages and used specimens.

Lineage	(1)	(2) ■	(3) ●	(4) ▲
1. <i>Hypsugo cadornae</i> (outgroup)	---	16.3	13.6	14.8
2. <i>Hypsugo savii</i> East Europe ■	14.1	---	8.1	8.6
3. <i>Hypsugo savii</i> West Europe ●	14.8	6.7	<b>0.3</b>	8.6
4. <i>Hypsugo savii</i> South Iberia ▲	15.2	9.0	9.9	<b>1.3</b>

Table 7. K2P genetic distances (%) between the main lineages of *Pipistrellus kuhlii* complex estimated from fragments of the mtDNA genes *cytb* (above diagonal) and *ND1* (below diagonal); the diagonal corresponds to the within-group genetic divergence estimated for the *cytb* in each lineage. See Fig. 2e and Appendix B for identification of lineages and used specimens.

Lineage	(1)	(2) ■	(3) ●
1. <i>Pipistrellus pipistrellus</i> (outgroup)	---	18.9	18.0
2. <i>Pipistrellus kuhlii</i> East Europe ■	13.8	<b>0.4</b>	5.8
3. <i>Pipistrellus kuhlii</i> West Europe ●	14.2	5.9	<b>0.2</b>

**Appendix A.** List of specimens, species codes, localities (NI, Northern Iberia; CI, Central Iberia; SI, Southern Iberia; AU, Austria; BL, Bulgaria; CR, Croatia; CZ, Czeck Republic; DK, Denmark; FR, France; GE, Germany; GR, Greece; HN, Hungary; SD, Sweden; SW, Switzerland; TK, Turkey), haplotypes codes for species and GenBank accession numbers of the samples used for an overall molecular screening of bat cryptic diversity in Iberia using a mtDNA *cytb* fragment.

SPECIMEN	SPECIES CODE	LOCATION	HAPLOTYPE	GenBank number	REFERENCE
<i>Rhinolophus euryale</i>	REU	NI	C1	DQ120916	This paper
<i>Rhinolophus euryale</i>	REU	NI	C1	DQ120916	This paper
<i>Rhinolophus euryale</i>	REU	SI	C1	DQ120916	This paper
<i>Rhinolophus euryale</i>	REU	SI	C1	DQ120916	This paper
<i>Rhinolophus euryale</i>	REU	BL	C1	DQ120916	This paper
<i>Rhinolophus ferrumequinum</i>	RFE	NI	C1	DQ120919	This paper
<i>Rhinolophus ferrumequinum</i>	RFE	NI	C1	DQ120919	This paper
<i>Rhinolophus ferrumequinum</i>	RFE	SI	C1	DQ120919	This paper
<i>Rhinolophus ferrumequinum</i>	RFE	SI	C1	DQ120919	This paper
<i>Rhinolophus ferrumequinum</i>	RFE	TK	C2	DQ120920	This paper
<i>Rhinolophus ferrumequinum</i>	RFE	TK	C1	DQ120919	This paper
<i>Rhinolophus hipposideros</i>	RHI	NI	C1	DQ120921	This paper
<i>Rhinolophus hipposideros</i>	RHI	NI	C2	DQ120922	This paper
<i>Rhinolophus hipposideros</i>	RHI	SI	C3	DQ120923	This paper
<i>Rhinolophus hipposideros</i>	RHI	SI	C3	DQ120923	This paper
<i>Rhinolophus hipposideros</i>	RHI	GR	C4	DQ120924	This paper
<i>Rhinolophus mehelyi</i>	RME	CI	C1	DQ120917	This paper
<i>Rhinolophus mehelyi</i>	RME	SI	C1	DQ120917	This paper
<i>Rhinolophus mehelyi</i>	RME	GR	C2	DQ120918	This paper
<i>Myotis alcaethoe</i>	MAL	NI	C1	DQ120882	This paper
<i>Myotis alcaethoe</i>	MAL	NI	C2	DQ120883	This paper
<i>Myotis alcaethoe</i>	MAL	SW	C3	AJ841955	Stadelman <i>et al.</i> 2004b
<i>Myotis bechsteinii</i>	MBE	NI	C1	DQ120899	This paper
<i>Myotis bechsteinii</i>	MBE	NI	C2	DQ120900	This paper
<i>Myotis bechsteinii</i>	MBE	SI	C3	DQ120901	This paper
<i>Myotis bechsteinii</i>	MBE	SI	C3	DQ120901	This paper
<i>Myotis bechsteinii</i>	MBE	SW	C4	AF376843	Ruedi & Mayer 2001
<i>Myotis blythii</i>	MBL	NI	C1	DQ120906	This paper
<i>Myotis blythii</i>	MBL	NI	C1	DQ120906	This paper
<i>Myotis blythii</i>	MBL	SI	C2	AF246256	Castella <i>et al.</i> 2000



<i>Myotis blythii</i>	MBL	SI	C2	AF246257	Castella <i>et al.</i> 2000
<i>Myotis blythii</i>	MBL	CZ	C3	AF246254	Castella <i>et al.</i> 2000
<i>Myotis blythii</i>	MBL	GR	C4	AF376841	Ruedi & Mayer 2001
<i>Myotis capaccinii</i>	MCA	NI	C1	DQ120878	This paper
<i>Myotis capaccinii</i>	MCA	CI	C1	DQ120878	This paper
<i>Myotis capaccinii</i>	MCA	SI	C1	DQ120878	This paper
<i>Myotis capaccinii</i>	MCA	SI	C1	DQ120878	This paper
<i>Myotis capaccinii</i>	MCA	GR	C2	AF376845	Ruedi & Mayer 2001
<i>Myotis emarginatus</i>	MEM	NI	C1	DQ120902	This paper
<i>Myotis emarginatus</i>	MEM	NI	C2	DQ120903	This paper
<i>Myotis emarginatus</i>	MEM	SI	C3	DQ120904	This paper
<i>Myotis emarginatus</i>	MEM	SI	C4	DQ120905	This paper
<i>Myotis emarginatus</i>	MEM	GR	C5	AF376849	Ruedi & Mayer 2001
<i>Myotis daubentonii</i>	MDA	NI	C1	DQ120896	This paper
<i>Myotis daubentonii</i>	MDA	NI	C2	AF376847	This paper
<i>Myotis daubentonii</i>	MDA	CI	C3	AF376862	Ruedi & Mayer 2001
<i>Myotis daubentonii</i>	MDA	SI	C4	DQ120897	This paper
<i>Myotis daubentonii</i>	MDA	SI	C5	DQ120898	This paper
<i>Myotis daubentonii</i>	MDA	GE	C2	AF376847	Ruedi & Mayer 2001
<i>Myotis myotis</i>	MMY	NI	C1	AF246241	This paper
<i>Myotis myotis</i>	MMY	NI	C1	AF246241	This paper
<i>Myotis myotis</i>	MMY	SI	C1	AF246241	Castella <i>et al.</i> 2000
<i>Myotis myotis</i>	MMY	SI	C2	AF246242	Castella <i>et al.</i> 2000
<i>Myotis myotis</i>	MMY	GE	C3	AF376860	Ruedi & Mayer 2001
<i>Myotis mystacinus</i>	MMT	NI	C1	DQ120879	This paper
<i>Myotis mystacinus</i>	MMT	NI	C2	DQ120880	This paper
<i>Myotis mystacinus</i>	MMT	CI	C3	DQ120881	This paper
<i>Myotis mystacinus</i>	MMT	CI	C3	DQ120881	This paper
<i>Myotis mystacinus</i>	MMT	GE	C4	AF376861	Ruedi & Mayer 2001
<i>Myotis nattereri</i>	MNA	NI	C1	DQ120884	This paper
<i>Myotis nattereri</i>	MNA	NI	C5	DQ120888	This paper
<i>Myotis nattereri</i>	MNA	SI	C7	DQ120890	This paper
<i>Myotis nattereri</i>	MNA	SI	C8	DQ120891	This paper
<i>Myotis nattereri</i>	MNA	GE	C9	DQ120892	This paper
<i>Myotis nattereri</i>	MNA	GR	C13	AF376863	Ruedi & Mayer 2001
<i>Pipistrellus kuhlii</i>	PKU	NI	C1	DQ120841	This paper
<i>Pipistrellus kuhlii</i>	PKU	NI	C4	DQ120844	This paper
<i>Pipistrellus kuhlii</i>	PKU	SI	C4	DQ120844	This paper
<i>Pipistrellus kuhlii</i>	PKU	SI	C4	DQ120844	This paper
<i>Pipistrellus kuhlii</i>	PKU	SW	C7	DQ120847	This paper

<i>Pipistrellus kuhlii</i>	PKU	GR	C9	AJ504444	Stadelmann <i>et al.</i> 2004a
<i>Pipistrellus nathusii</i>	PNA	NI	C1	DQ120849	This paper
<i>Pipistrellus nathusii</i>	PNA	SD	C2	DQ120850	This paper
<i>Pipistrellus nathusii</i>	PNA	SW	C3	AJ504446	Stadelmann <i>et al.</i> 2004a
<i>Pipistrellus pipistrellus</i>	PPI	NI	C1	DQ120851	This paper
<i>Pipistrellus pipistrellus</i>	PPI	NI	C2	DQ120852	This paper
<i>Pipistrellus pipistrellus</i>	PPI	SI	C3	DQ120853	This paper
<i>Pipistrellus pipistrellus</i>	PPI	SI	C4	DQ120854	This paper
<i>Pipistrellus pipistrellus</i>	PPI	GR	C5	AJ504443	Stadelmann <i>et al.</i> 2004a
<i>Pipistrellus pygmaeus</i>	PPY	NI	C1	DQ120855	This paper
<i>Pipistrellus pygmaeus</i>	PPY	NI	C2	DQ120856	This paper
<i>Pipistrellus pygmaeus</i>	PPY	SI	C2	DQ120856	This paper
<i>Pipistrellus pygmaeus</i>	PPY	SI	C1	DQ120855	This paper
<i>Pipistrellus pygmaeus</i>	PPY	GR	C3	AJ504441	Stadelmann <i>et al.</i> 2004a
<i>Hypsugo savii</i>	HSA	NI	C3	DQ120859	This paper
<i>Hypsugo savii</i>	HSA	NI	C4	AJ504450	This paper
<i>Hypsugo savii</i>	HSA	SI	C8	DQ120863	This paper
<i>Hypsugo savii</i>	HSA	SI	C9	DQ120864	This paper
<i>Hypsugo savii</i>	HSA	SW	C4	AJ504450	Stadelmann <i>et al.</i> 2004a
<i>Hypsugo savii</i>	HSA	GR	C11	DQ120866	This paper
<i>Nyctalus lasiopterus</i>	NLA	NI	C1	DQ120867	This paper
<i>Nyctalus lasiopterus</i>	NLA	NI	C2	DQ120868	This paper
<i>Nyctalus lasiopterus</i>	NLA	SI	C3	DQ120869	This paper
<i>Nyctalus lasiopterus</i>	NLA	SI	C4	DQ120870	This paper
<i>Nyctalus lasiopterus</i>	NLA	HN	C5	DQ120871	This paper
<i>Nyctalus leisleri</i>	NLE	NI	C1	DQ120875	This paper
<i>Nyctalus leisleri</i>	NLE	NI	C2	DQ120876	This paper
<i>Nyctalus leisleri</i>	NLE	SI	C3	DQ120877	This paper
<i>Nyctalus leisleri</i>	NLE	SI	C3	DQ120877	This paper
<i>Nyctalus leisleri</i>	NLE	SW	C4	AF376832	Ruedi & Mayer 2001
<i>Nyctalus noctula</i>	NNO	NI	C1	DQ120872	This paper
<i>Nyctalus noctula</i>	NNO	NI	C2	DQ120873	This paper
<i>Nyctalus noctula</i>	NNO	GR	C3	DQ120874	This paper
<i>Eptesicus serotinus</i>	ESE	NI	C1	DQ120832	This paper
<i>Eptesicus serotinus</i>	ESE	NI	C3	DQ120834	This paper
<i>Eptesicus serotinus</i>	ESE	SI	C7	DQ120838	This paper
<i>Eptesicus serotinus</i>	ESE	SI	C8	DQ120839	This paper
<i>Eptesicus serotinus</i>	ESE	GR	C9	AF376837	Ruedi & Mayer 2001
<i>Barbastella barbastellus</i>	BBA	NI	C1	AF513746	Juste <i>et al.</i> 2003
<i>Barbastella barbastellus</i>	BBA	NI	C2	AF513749	Juste <i>et al.</i> 2003

<i>Barbastella barbastellus</i>	BBA	SI	C3	AF513750	Juste <i>et al.</i> 2003
<i>Barbastella barbastellus</i>	BBA	SI	C3	AF513750	Juste <i>et al.</i> 2003
<i>Barbastella barbastellus</i>	BBA	SW	C2	AF513749	Juste <i>et al.</i> 2003
<i>Barbastella barbastellus</i>	BBA	TK	C4	AF513751	Juste <i>et al.</i> 2003
<i>Barbastella barbastellus</i>	BBA	TK	C5	AF513753	Juste <i>et al.</i> 2003
<i>Plecotus auritus</i>	PAR	NI	C1	AY306211	Juste <i>et al.</i> 2004
<i>Plecotus auritus</i>	PAR	NI	C2	AF513760	Juste <i>et al.</i> 2004
<i>Plecotus auritus</i>	PAR	CI	C5	AF513761	Juste <i>et al.</i> 2004
<i>Plecotus auritus</i>	PAR	CI	C6	AF513762	Juste <i>et al.</i> 2004
<i>Plecotus auritus</i>	PAR	DK/GE/SW	C8	AF513756	Juste <i>et al.</i> 2004
<i>Plecotus auritus</i>	PAR	DK	C9	AF513757	Juste <i>et al.</i> 2004
<i>Plecotus auritus</i>	PAR	SW	C10	AF513758	Juste <i>et al.</i> 2004
<i>Plecotus auritus</i>	PAR	SW	C11	AF513759	Juste <i>et al.</i> 2004
<i>Plecotus auritus</i>	PAR	SW	C12	AF513768	Juste <i>et al.</i> 2004
<i>Plecotus auritus</i>	PAR	AU	C13	AF513769	Juste <i>et al.</i> 2004
<i>Plecotus austriacus</i>	PAU	NI	C1	AF513781	Juste <i>et al.</i> 2004
<i>Plecotus austriacus</i>	PAU	NI	C2	AF513787	Juste <i>et al.</i> 2004
<i>Plecotus austriacus</i>	PAU	SI	C3	AF513776	Juste <i>et al.</i> 2004
<i>Plecotus austriacus</i>	PAU	SI	C4	AF513788	Juste <i>et al.</i> 2004
<i>Plecotus austriacus</i>	PAU	AU/GE/ GR/FR/SW	C5	AF513774	Juste <i>et al.</i> 2004
<i>Plecotus macrobullaris</i>	PMA	NI	C1	AY306213	Juste <i>et al.</i> 2004
<i>Plecotus macrobullaris</i>	PMA	NI	C2	AY306214	Juste <i>et al.</i> 2004
<i>Plecotus macrobullaris</i>	PMA	SW	C3	AF513800	Juste <i>et al.</i> 2004
<i>Miniopterus schreibersii</i>	MSC	NI	C1	DQ120911	This paper
<i>Miniopterus schreibersii</i>	MSC	NI	C2	AF376830	Ruedi & Mayer 2001
<i>Miniopterus schreibersii</i>	MSC	SI	C3	DQ120912	This paper
<i>Miniopterus schreibersii</i>	MSC	SI	C4	DQ120913	This paper
<i>Miniopterus schreibersii</i>	MSC	FR	C2	AF376830	This paper
<i>Miniopterus schreibersii</i>	MSC	GR	C5	DQ120914	This paper
<i>Miniopterus schreibersii</i>	MSC	TK	C6	DQ120915	This paper
<i>Tadarida teniotis</i>	TTE	NI	C1	DQ120907	This paper
<i>Tadarida teniotis</i>	TTE	CI	C1	DQ120907	This paper
<i>Tadarida teniotis</i>	TTE	SI	C1	DQ120907	This paper
<i>Tadarida teniotis</i>	TTE	SI	C2	DQ120908	This paper
<i>Tadarida teniotis</i>	TTE	TK	C3	DQ120909	This paper
<i>Tadarida teniotis</i>	TTE	TK	C4	DQ120910	This paper

**Appendix B.** List of specimens, localities (codes follow Appendix A except for IR, Iran; LS, Laos), haplotypes codes by gene (*cytb*, *ND1* and *RAG2*) and GenBank accession numbers of the samples used for the study of the five complexes showing genetic disruption at the mtDNA.

SPECIES	LOCATION	<i>cytb</i> Hapl	<i>cytb</i>	<i>ND1</i> Hapl	<i>ND1</i>	<i>RAG2</i> Hapl	<i>RAG2</i>	REFERENCE
<b><i>Myotis nattereri</i> complex</b>								
<i>Myotis nattereri</i>	NI	C1	DQ120884	—	—	R1	DQ120813	This paper
<i>Myotis nattereri</i>	NI	C2	DQ120885	—	—	—	—	This paper
<i>Myotis nattereri</i>	NI	C3	DQ120886	N1	DQ120801	R2	DQ120814	This paper
<i>Myotis nattereri</i>	NI	C4	DQ120887	—	—	—	—	This paper
<i>Myotis nattereri</i>	NI	C5	DQ120888	—	—	—	—	This paper
<i>Myotis nattereri</i>	CI	C6	DQ120889	—	—	—	—	This paper
<i>Myotis nattereri</i>	SI	C7	DQ120890	—	—	—	—	This paper
<i>Myotis nattereri</i>	SI	C8	DQ120891	N2	DQ120802	R3	DQ120815	This paper
<i>Myotis nattereri</i>	SI	C7	DQ120890	—	—	R4	DQ120816	This paper
<i>Myotis nattereri</i>	GE	C9	DQ120892	—	—	—	—	This paper
<i>Myotis nattereri</i>	GE	C9	DQ120892	—	—	—	—	This paper
<i>Myotis nattereri</i>	GE	C9	DQ120892	—	—	—	—	This paper
<i>Myotis nattereri</i>	GE	C9	DQ120892	—	—	—	—	This paper
<i>Myotis nattereri</i>	GE	C10	DQ120893	—	—	—	—	This paper
<i>Myotis nattereri</i>	GE	C11	DQ120894	—	—	—	—	This paper
<i>Myotis nattereri</i>	GE	C12	DQ120895	—	—	—	—	This paper
<i>Myotis nattereri</i>	SW	C9	DQ120892	—	—	R5	DQ120817	This paper
<i>Myotis nattereri</i>	GR	C13	AF376863	N3	AY033984	—	—	Ruedi and Mayer, 2001
<i>Myotis nattereri</i>	HN	—	—	N4	AF401439	—	—	Mayer and Helversen, 2001

<i>Myotis schaubi</i>	IR	<i>Myotis schaubi</i>	AF376868	<i>M. schaubi</i>	AY033955	<i>M. schaubi</i>	DQ120818	Ruedi and Mayer, 2001 and this paper
<i>Myotis myotis</i> (outgroup)	NI	<i>Myotis myotis</i>	AF246241	<i>M. myotis</i>	DQ120800	<i>M. myotis</i>	DQ120812	This paper
<b><i>Eptesicus serotinus</i> complex</b>								
<i>Eptesicus serotinus</i>	NI	C1	DQ120832	—	—	—	—	This paper
<i>Eptesicus serotinus</i>	NI	C2	DQ120833	—	—	R1	DQ120806	This paper
<i>Eptesicus serotinus</i>	NI	C3	DQ120834	—	—	—	—	This paper
<i>Eptesicus serotinus</i>	NI	C3	DQ120834	N1	DQ120803	R2	DQ120807	This paper
<i>Eptesicus serotinus</i>	CI	C4	DQ120835	—	—	—	—	This paper
<i>Eptesicus serotinus</i>	CI	C3	DQ120834	—	—	—	—	This paper
<i>Eptesicus serotinus</i>	CI	C5	DQ120836	—	—	—	—	This paper
<i>Eptesicus serotinus</i>	CI	C6	DQ120837	—	—	—	—	This paper
<i>Eptesicus serotinus</i>	SI	C7	DQ120838	—	—	—	—	This paper
<i>Eptesicus serotinus</i>	SI	C8	DQ120839	—	—	R3	DQ120808	This paper
<i>Eptesicus serotinus</i>	SI	C8	DQ120839	N2	DQ120804	R4	DQ120809	This paper
<i>Eptesicus serotinus</i>	SI	C8	DQ120839	—	—	—	—	This paper
<i>Eptesicus serotinus</i>	GR	C9	AF376837	N3	AY033950	—	—	Ruedi and Mayer, 2001
<i>Eptesicus serotinus</i>	GR	—	—	N4	AF401471	—	—	Mayer and Helversen, 2001
<i>Eptesicus serotinus</i>	GE	—	—	N5	AF401472	—	—	Mayer and Helversen, 2001
<i>Eptesicus nilssonii</i>	GE	<i>E. nilssonii</i>	AF376836	<i>E. nilssonii</i>	AY033987	<i>E. nilssonii</i>	DQ120811	Ruedi and Mayer, 2001 and this paper
<i>Eptesicus bottae anatolicus</i> (outgroup)	TK	<i>E. b. anatolicus</i>	DQ120840	<i>E. b. anatolicus</i>	DQ120805	<i>E. b. anatolicus</i>	DQ120810	This paper
<b><i>Plecotus auritus</i> complex</b>								
<i>Plecotus auritus</i>	NI	C1	AY306211	—	—	R1	DQ120819	Juste et al., 2004 and this paper
<i>Plecotus auritus</i>	NI	C2	AF513760	—	—	—	—	Juste et al., 2004
<i>Plecotus auritus</i>	NI	C3	AF513765	—	—	—	—	Juste et al., 2004

<i>Plecotus auritus</i>	NI	—	—	N1	AY328906	—	—	Garin et al., 2003
<i>Plecotus auritus</i>	NI	C4	AF513764	—	—	—	—	Juste et al., 2004
<i>Plecotus auritus</i>	NI	—	—	N2	AF516273	—	—	Kiefer et al., 2002
<i>Plecotus auritus</i>	CI	C5	AF513761	—	—	R2	DQ120820	Juste et al., 2004 and this paper
<i>Plecotus auritus</i>	CI	C6	AF513762	—	—	R2	DQ120820	Juste et al., 2004 and this paper
<i>Plecotus auritus</i>	CI	C7	AF513767	—	—	—	—	Juste et al., 2004
<i>Plecotus auritus</i>	DK/GE/SW	C8	AF513756	—	—	—	—	Juste et al., 2004
<i>Plecotus auritus</i>	DK	C9	AF513757	—	—	—	—	Juste et al., 2004
<i>Plecotus auritus</i>	SW	C10	AF513758	—	—	R3	DQ120821	Juste et al., 2004 and this paper
<i>Plecotus auritus</i>	SW	C11	AF513759	—	—	—	—	Juste et al., 2004
<i>Plecotus auritus</i>	SW	C12	AF513768	—	—	—	—	Juste et al., 2004
<i>Plecotus auritus</i>	AU	C13	AF513769	—	—	—	—	Juste et al., 2004
<i>Plecotus auritus</i>	CR	—	—	N3	AF401369	—	—	Kiefer et al., 2002
<i>Plecotus auritus</i>	GE	—	—	N4	AF401374	—	—	Kiefer et al., 2002
<i>Plecotus auritus</i>	AU	—	—	N5	AF516276	—	—	Kiefer <i>et al.</i> , 2002
<i>Plecotus macrobullaris</i> (outgroup)	NI	<i>P. macrobullaris</i>	AY306213	<i>P. macrobullaris</i>	AY328904	<i>P. macrobullaris</i>	DQ120822	Garin et al., 2003 ; Juste et al., 2004 and this paper

---

### ***Hypsugo savii* complex**

<i>Hypsugo savii</i>	NI	C1	DQ120857	—	—	—	—	This paper
<i>Hypsugo savii</i>	NI	C2	DQ120858	—	—	—	—	This paper
<i>Hypsugo savii</i>	NI	C3	DQ120859	—	—	—	—	This paper
<i>Hypsugo savii</i>	NI	C4	AJ504450	—	—	R4	DQ120826	This paper
<i>Hypsugo savii</i>	NI	C4	AJ504450	—	—	—	—	This paper
<i>Hypsugo savii</i>	SI	C5	DQ120860	—	—	—	—	This paper
<i>Hypsugo savii</i>	SI	C6	DQ120861	N1	DQ120798	R3	DQ120825	This paper

<i>Hypsugo savii</i>	SI	C7	DQ120862	—	—	—	—	This paper
<i>Hypsugo savii</i>	SI	C8	DQ120863	—	—	—	—	This paper
<i>Hypsugo savii</i>	SI	C8	DQ120863	—	—	—	—	This paper
<i>Hypsugo savii</i>	SI	C9	DQ120864	N2	DQ120799	R1	DQ120823	This paper
<i>Hypsugo savii</i>	SI	C10	DQ120865	—	—	R2	DQ120824	This paper
<i>Hypsugo savii</i>	SW	C4	AJ504450	—	—	R5	DQ120827	Stadelman et al., 2004a and this paper
<i>Hypsugo savii</i>	GR	C11	DQ120866	—	—	R4	DQ120826	This paper
<i>Hypsugo savii</i>	TK	—	—	N3	AF401417	—	—	Mayer and Helversen, 2001
<i>Hypsugo savii</i>	TK	—	—	N4	AF401418	—	—	Mayer and Helversen, 2001
<i>Hypsugo savii</i>	GR	—	—	N5	AF401419	—	—	Mayer and Helversen, 2001
<i>Hypsugo cadornae</i> (outgroup)	LS	<i>H. cadornae</i>	DQ318883	<i>H. cadornae</i>	DQ120797	<i>H. cadornae</i>	DQ120828	This paper
<b><i>Pipistrellus kuhlii</i> complex</b>								
<i>Pipistrellus kuhlii</i>	NI	C1	DQ120841	N1	DQ120795	R1	DQ120829	This paper
<i>Pipistrellus kuhlii</i>	NI	C2	DQ120842	—	—	—	—	This paper
<i>Pipistrellus kuhlii</i>	NI	C3	DQ120843	—	—	—	—	This paper
<i>Pipistrellus kuhlii</i>	NI	C4	DQ120844	—	—	—	—	This paper
<i>Pipistrellus kuhlii</i>	SI	C4	DQ120844	—	—	R1	DQ120829	This paper
<i>Pipistrellus kuhlii</i>	SI	C4	DQ120844	—	—	—	—	This paper
<i>Pipistrellus kuhlii</i>	SI	C5	DQ120845	—	—	—	—	This paper
<i>Pipistrellus kuhlii</i>	SI	C6	DQ120846	N5	DQ120796	R1	DQ120829	This paper
<i>Pipistrellus kuhlii</i>	SW	C7	DQ120847	—	—	R1	DQ120829	This paper
<i>Pipistrellus kuhlii</i>	SW	C8	DQ120848	—	—	R2	DQ120830	This paper
<i>Pipistrellus kuhlii</i>	GR	C9	AJ504444	—	—	R1	DQ120829	Stadelmann et al., 2004a and this paper
<i>Pipistrellus kuhlii</i>	GR	—	—	N2	AF401414	—	—	Mayer and Helversen, 2001
<i>Pipistrellus kuhlii</i>	GR	—	—	N3	AF401415	—	—	Mayer and Helversen, 2001

<i>Pipistrellus kuhlii</i>	GR	—	—	N4	AF401416	—	—	Mayer and Helversen, 2001
<i>Pipistrellus pipistrellus</i> (outgroup)	SI	<i>P. pipistrellus</i>	DQ120854	<i>P. pipistrellus</i>	DQ120794	<i>P. pipistrellus</i>	DQ120831	This paper

---



## FIGURE CAPTIONS

Fig. 1. Maximum values of pairwise K2P genetic distances for a fragment of the mtDNA gene *cytb* for the 28 bat species known in Iberia. In shadow are those species complexes that showed distance values over 5.5 %. Additional information (species codes, samples, locations, haplotypes, etc.) is given in Appendix A and Table 1.

Fig. 2. Phylogenetic relationships among haplotypes of the *cytb* and *ND1* genes for European bats of the species complexes: a) *Myotis nattereri*, b) *Eptesicus serotinus*, c) *Plecotus auritus* d) *Hypsugo savii*, e) *Pipistrellus kuhlii*. Localities of the haplotypes are shown in bold in the trees (NI, Northern Iberia; CI, Central Iberia; SI, Southern Iberia; AU, Austria; CR, Croatia; DK, Denmark; GE, Germany; GR, Greece; HN, Hungary; SW, Switzerland; TK, Turkey). Reconstructions are NJ trees based on corrected genetic distances (see Table 2 for details of each model). Bootstrap values for NJ and ML trees are indicated above and below nodes, respectively. The geographic locations of the haplotypes are shown in an approximate distribution map for each species complex in the western Palaearctic (shadow area). See Appendix B for haplotype codes. Distance units correspond to 0.02 substitutions/site. Nodes in bold are also supported by phylogenetic reconstructions using *RAG2* sequences and based on NJ algorithm and ML search with corrected genetic distances (see Table 2 for details of each model).

Fig. 3. Phylogenetic relationships based on unrooted median-joining networks among haplotypes of the *RAG2* gene for European bats of the species complexes: a) *Myotis nattereri*, b) *Eptesicus serotinus*, c) *Plecotus auritus* d) *Hypsugo savii*, e) *Pipistrellus kuhlii*. Little black dots represent reconstructed missing haplotypes (median vectors) in the sampling. Colours and lineages codes follow Fig. 2 and Tables 1-7. For each representation,

distances between haplotypes are proportional to the number of mutated positions. The geographic locations of the haplotypes (NI, Northern Iberia; CI, Central Iberia; SI, Southern Iberia; GR, Greece; SW, Switzerland) are shown in an approximate distribution map for each species complex in the western Palaeartic (shadow area) in the Fig. 2. See Appendix B for haplotype codes.

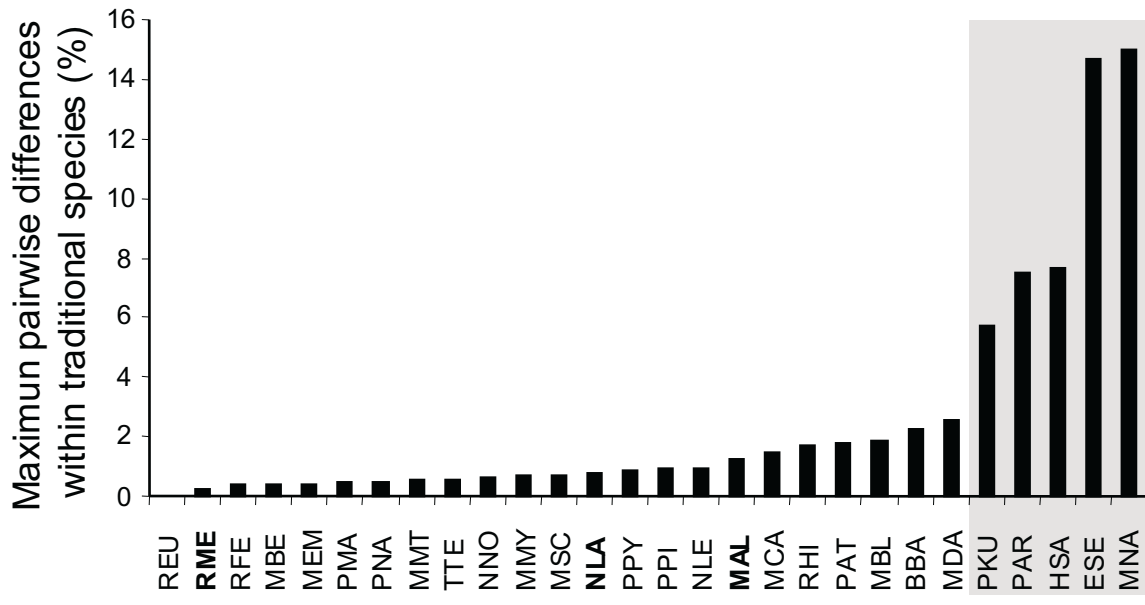

**"Myotis nattereri" complex**

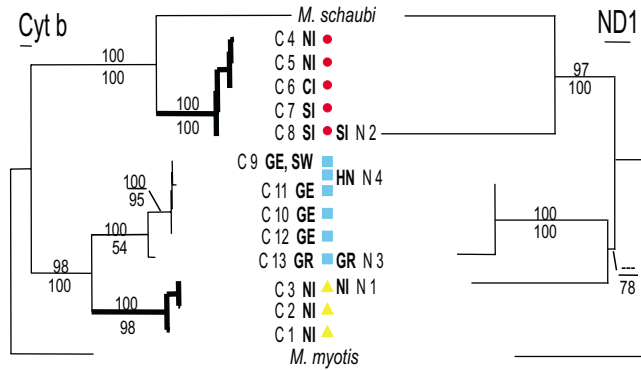
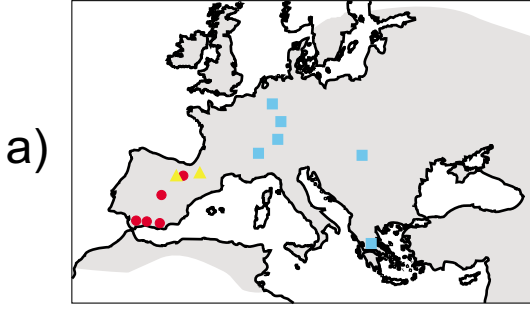

**"Eptesicus serotinus" complex**

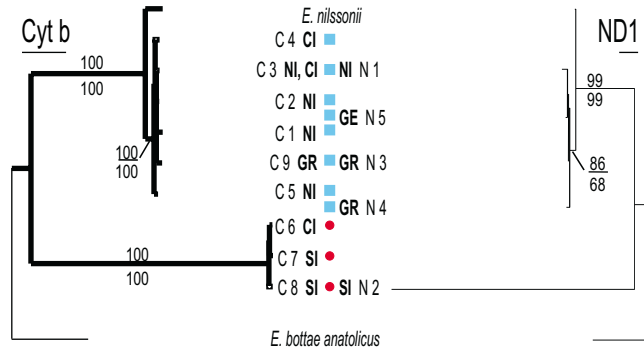
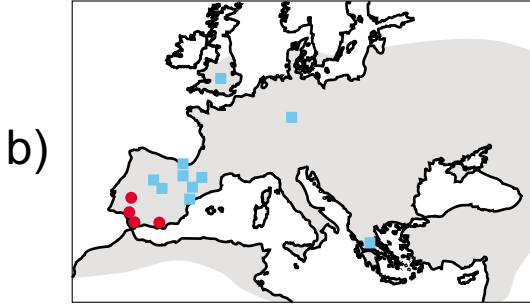

**"Plecotus auritus" complex**

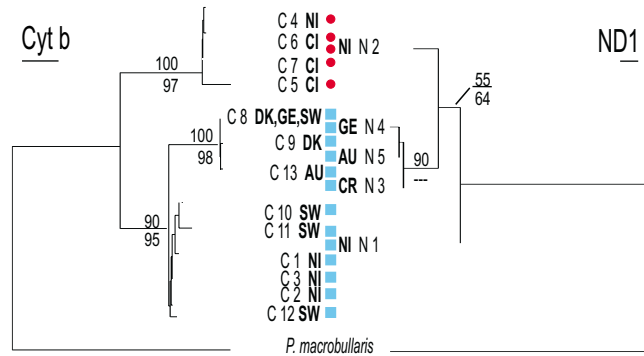
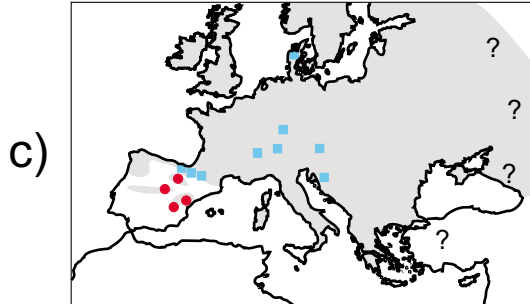

**"Hypsugo savii" complex**

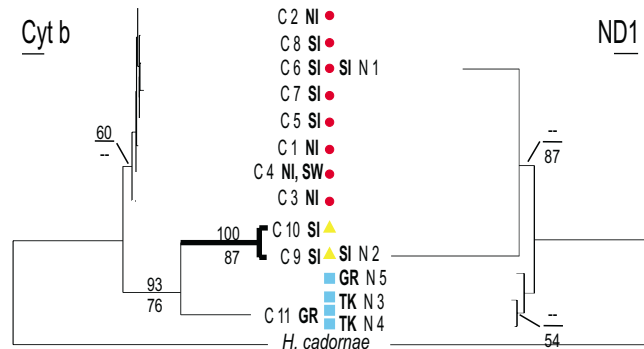
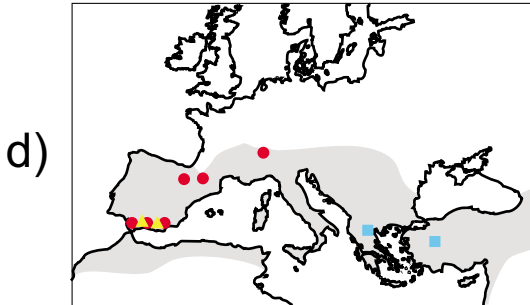

**"Pipistrellus kuhlii" complex**

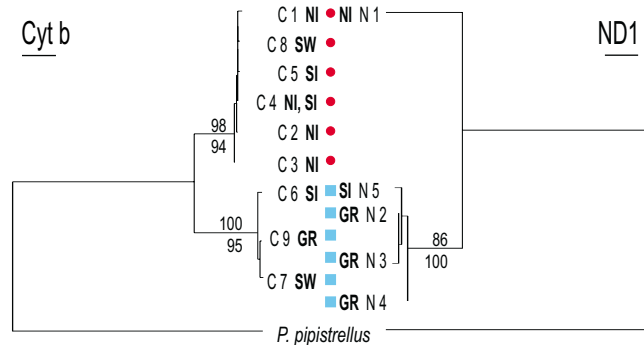
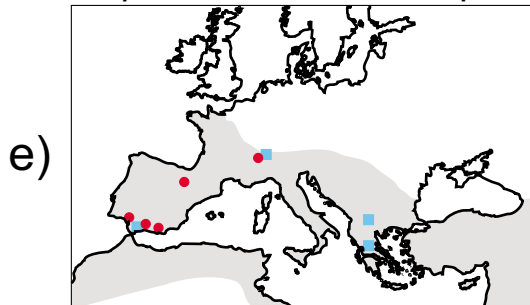

a) **"Myotis nattereri" complex**

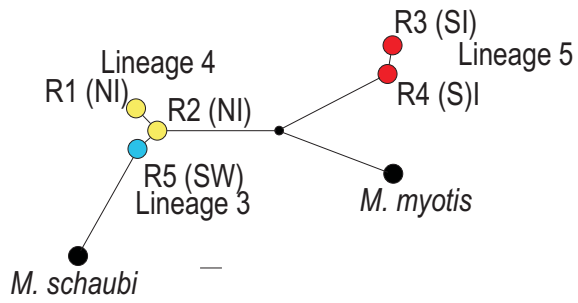

b) **"Eptesicus serotinus" complex**

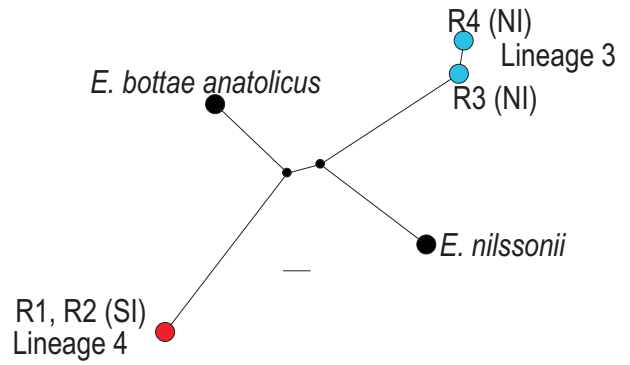

c) **"Plecotus auritus" complex**

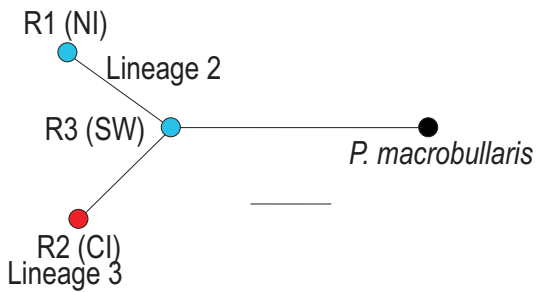

d) **"Hypsugo savii" complex**

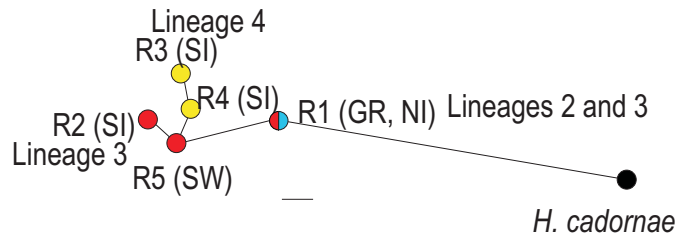

e) **"Pipistrellus kuhlii" complex**

